

25036 AVE. STAMFORD, VALENCIA, CA 91355
 GRUBER SYSTEMS INC.
 GRUBER SYSTEMS RESERVES THE RIGHT TO CHANGE THIS INFORMATION AT ANY TIME WITHOUT PRIOR NOTICE

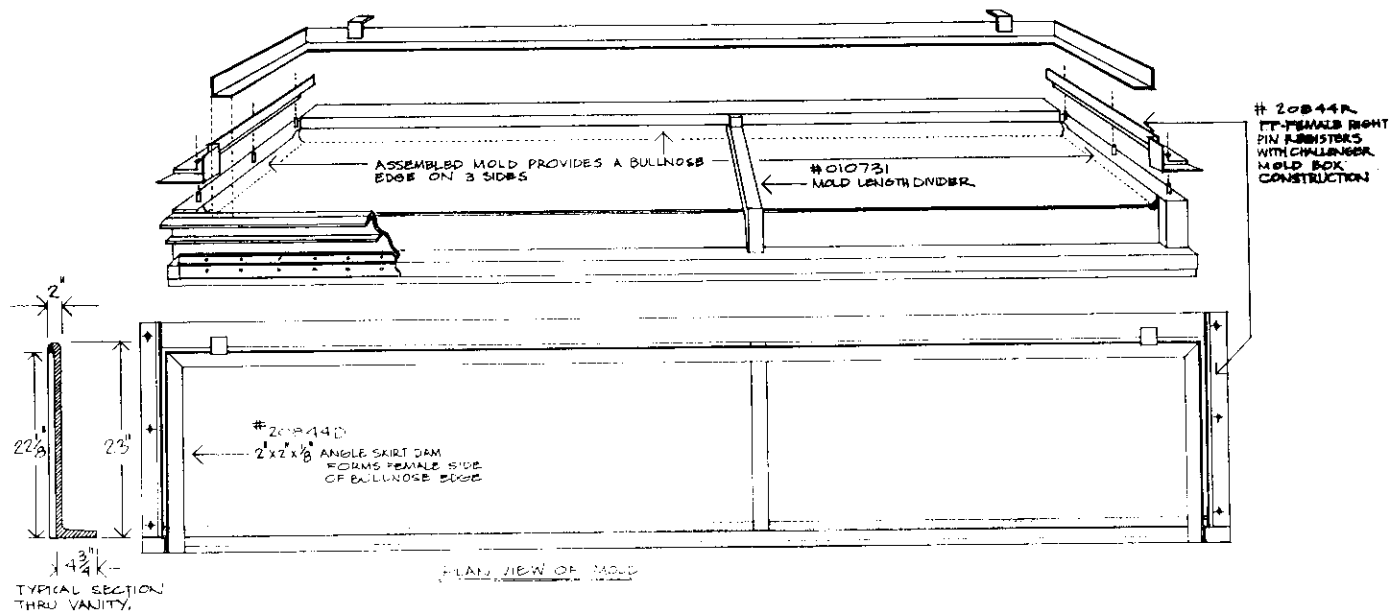

	20844 R	FF-FEMALE RIGHT	
	20844 L	FF-FEMALE LEFT	
	010731	YEL. DIVIDER SD	
	20844 D	ALUM. DAM FOR BLNSE	
	CATALOG No.	DESCRIPTION	LIST PRICE
MALE	20844	523-NB-146" W/2" BLNSE	
FEMALE			
INSERT			
NAME	523-NB-144 2" BULLNOSE 4 3/4" B.S. VTY		©1993
			CAST WEIGHT
			SCALE NO SCALE
			DATE 8-20-93
			REF. B-PD-1600

25636 AVE. STANFORD, VALENCIA, CA 91355
 GRUBER SYSTEMS RESERVES THE RIGHT TO CHANGE THIS INFORMATION AT ANY TIME WITHOUT PRIOR NOTICE

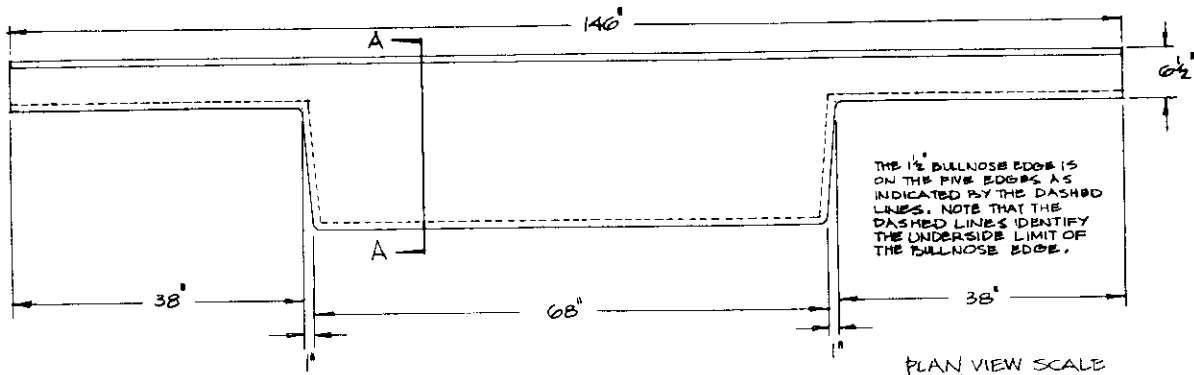

PLAN VIEW SCALE
1/2" = 1'0"

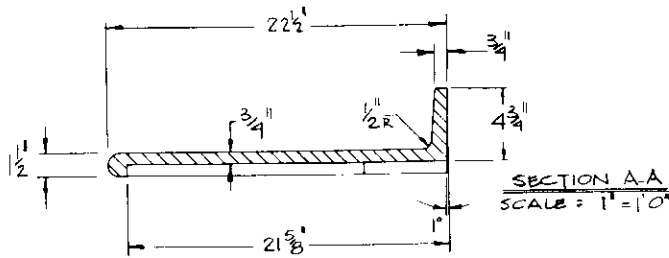

SECTION A-A
SCALE = 1" = 1'0"

20846 D	ALUMINUM DAM	
20845 B	YELLOW DIVIDER (522)	
CATALOG No.	DESCRIPTION	LIST PRICE

MALE	20846	522-NB-146 DBL. BANJO		CAST WEIGHT
FEMALE				SCALE NOTED
INSERT				DATE 8-19-93
NAME	522-NB-146 1 1/2" BULLNOSE DBL. BANJO VANITY		©1993	REF. B-PD-1598

ISSUED BY GRUBER SYSTEMS INC. 25636 AVE. STANFORD, VALENCIA, CA 91355
 GRUBER SYSTEMS RESERVES THE RIGHT TO CHANGE THIS INFORMATION AT ANY TIME WITHOUT PRIOR NOTICE

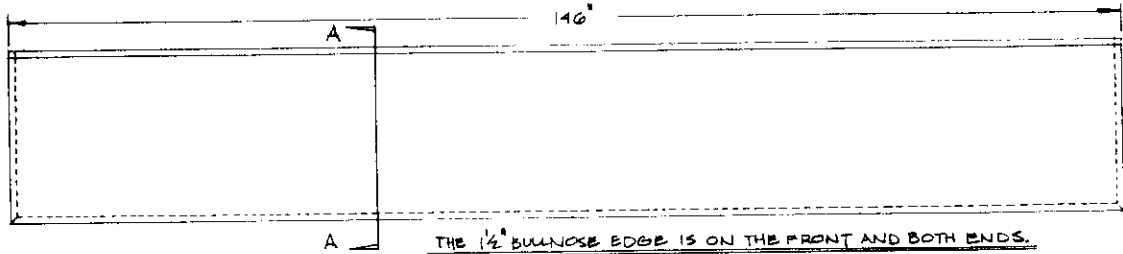

THE 1/2" BULLNOSE EDGE IS ON THE FRONT AND BOTH ENDS.

PLAN VIEW SCALE
 1/2" = 1'0"

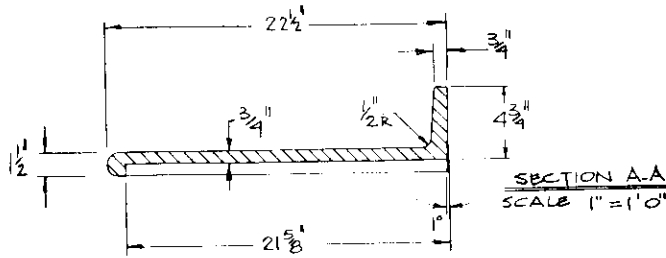

SECTION A-A
 SCALE 1" = 1'0"

	20845 B	YELL. DIV./ALUM. DAM (522)	
	20845 R	FF-522-NB-140. 1 1/2 B/N. RT.	
	CATALOG No.	DESCRIPTION	LIST PRICE
MALE	20845	522-NB-140. 1 1/2 B/N.	
FEMALE	20845 L	FF-522-NB-140. 1 1/2 B/N. L.F.T.	
INSERT			
NAME	522-NB-140 1 1/2" BULLNOSE VANITY		
		©1993	CAST WEIGHT
			SCALE NOTED
			DATE 8-19-93
			REF. B-PD-1599

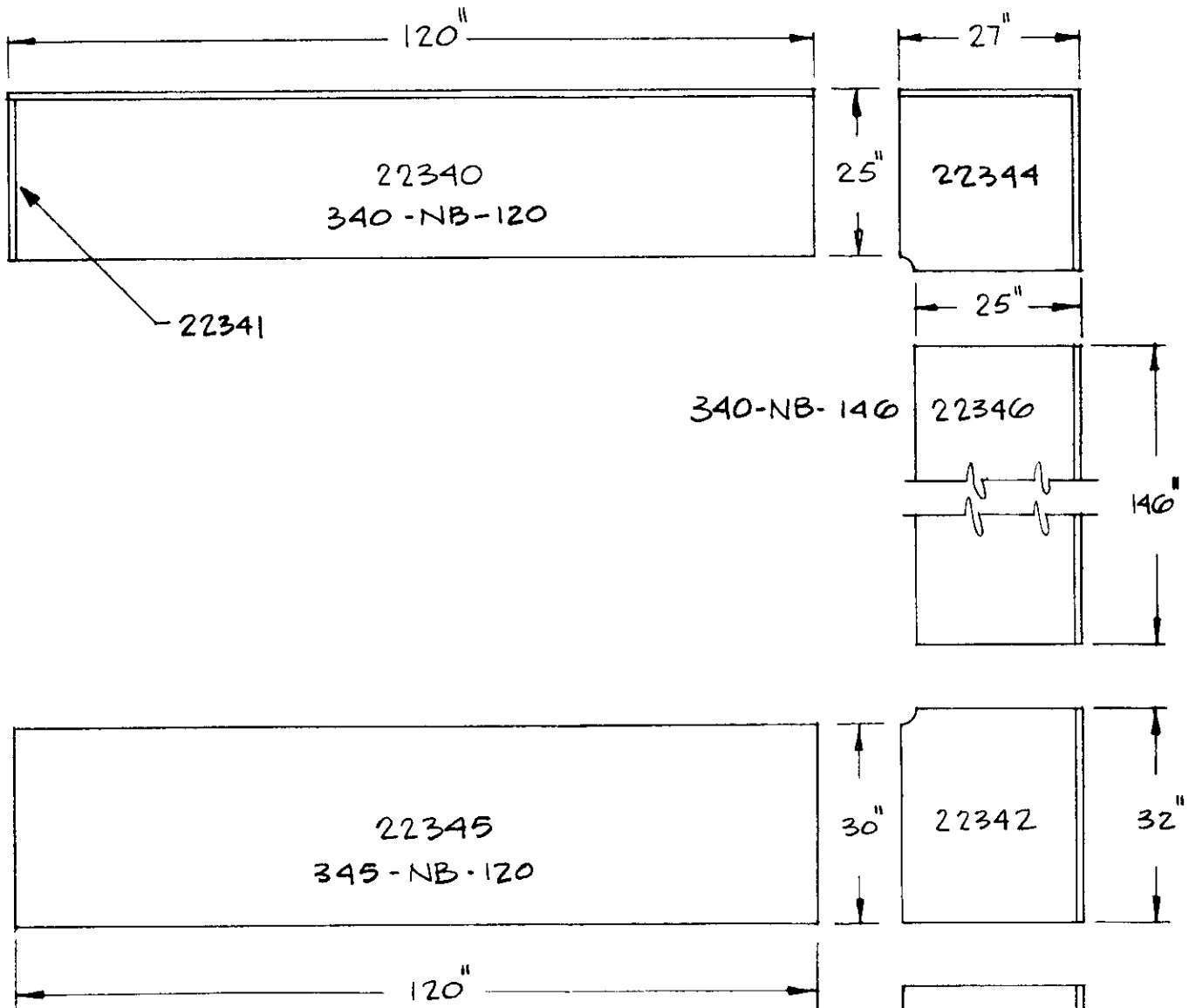

01087	340 YELLOW DIVIDER	
01087-R	340 -REINFORCED	
22346	25"x140" DECK W/5 1/2" BACKSPLASH	
22341	ENDSPLASH - 6 CAVITY	
22342	RIGHT CORNER - PENINSULA	
22343	LEFT CORNER - PENINSULA	
22344	DOUBLE CORNER	
22345	30"x120" PENINSULA	
CATALOG No.	DESCRIPTION	LIST PRICE

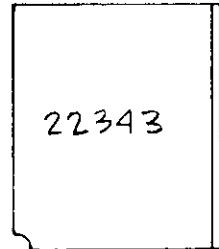

MALE	22340	25"x120" DECK W/5 1/2" BACKSPLASH	CAST WEIGHT SCALE 1/2" = 10" DATE 5-14-93
FEMALE			
INSERT			
NAME	KITCHEN COUNTERTOP - SERIES 340		©1992 REF.

25636 AVE. STANFORD, VALENCIA, CA 91355
 ISSUED BY GRUBER SYSTEMS INC.
 GRUBER SYSTEMS RESERVES THE RIGHT TO CHANGE THIS INFORMATION AT ANY TIME WITHOUT PRIOR NOTICE

KITCHEN DECK 4425-146 CATALOG # 22352
 146" X 25" X 9/16" WITH LOW ENDSPLASHES AND LOW BACKSPLASH

KITCHEN DECK 4430-NB-146 CATALOG # 22350
 146" X 30" X 9/16" WITHOUT BACKSPLASH

KITCHEN DECK 4436-NB-146 CATALOG # 22351
 146" X 30" X 9/16" WITHOUT BACKSPLASH

KITCHEN DECK PLAN VIEWS

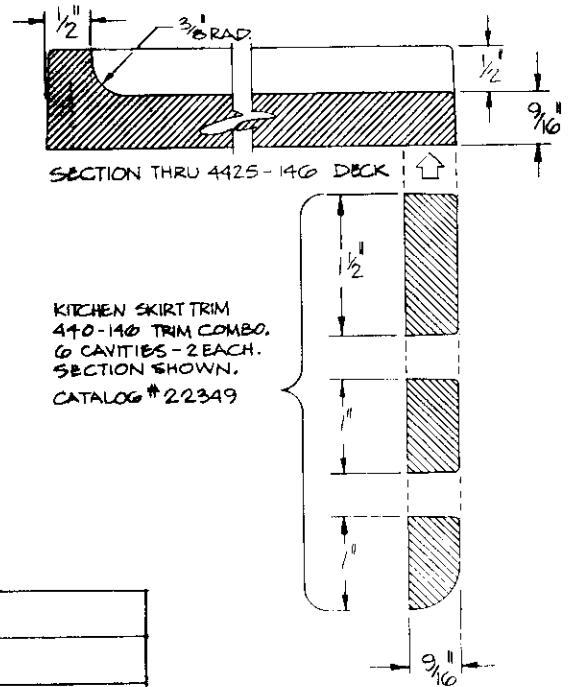

01094	4425-146 YELL DIVIDER	
22350	4430-NB-146	
22351	4436-NB-146	
22349	440-146 TRIM COMBO.	
CATALOG No.	DESCRIPTION	LIST PRICE

MALE	22352	4425-146 W/LOW SPLASHES		CAST WEIGHT
FEMALE				SCALE NO SCALE
INSERT				DATE 5-14-93
NAME	KITCHEN COUNTERTOPS - 440 SERIES		©1992	REF. B-PD-1015

ISSUED BY GRUBER SYSTEMS INC. 25636 AVE. STANFORD, VALENCIA, CA 91355
GRUBER SYSTEMS RESERVES THE RIGHT TO CHANGE THIS INFORMATION AT ANY TIME WITHOUT PRIOR NOTICE

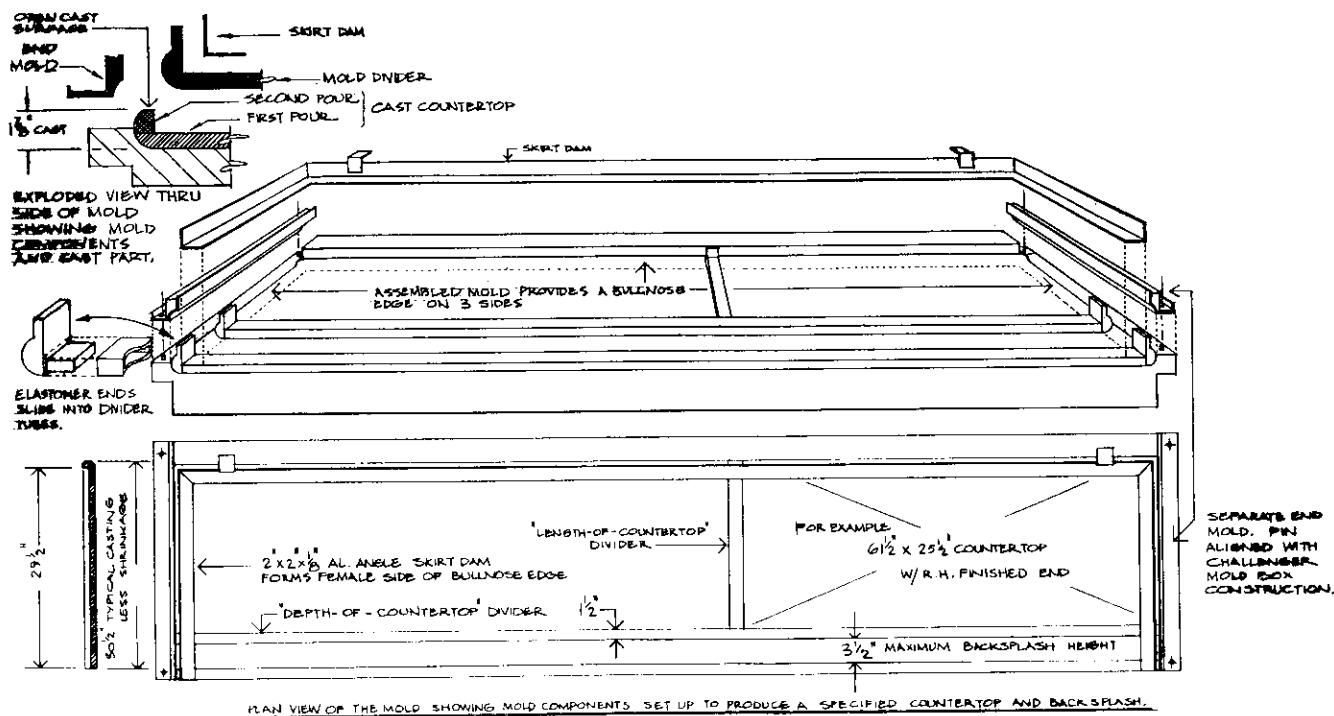

	22356D	FF-ALUM DAM (630)	
	22356B	YELL/ALUM DAM (630)	
	22356R	FF-630-RIGHT	
	CATALOG No.	DESCRIPTION	LIST PRICE
MALE	22356	630-NB-146 W/2"BLNSE	
FEMALE	22356L	FF-630-LEFT	
INSERT			
NAME	KITCHEN DECK 140" x 30" W/2" BULLNOSE EDGE		©1992
			CAST WEIGHT
			SCALE NO SCALE
			DATE 5-14-93
			REF. B-PD-1524

25636 AVE. STANFORD, VALENCIA, CA 91355
ISSUED BY GRUBER SYSTEMS INC.
GRUBER SYSTEMS RESERVES THE RIGHT TO CHANGE THIS INFORMATION AT ANY TIME WITHOUT PRIOR NOTICE

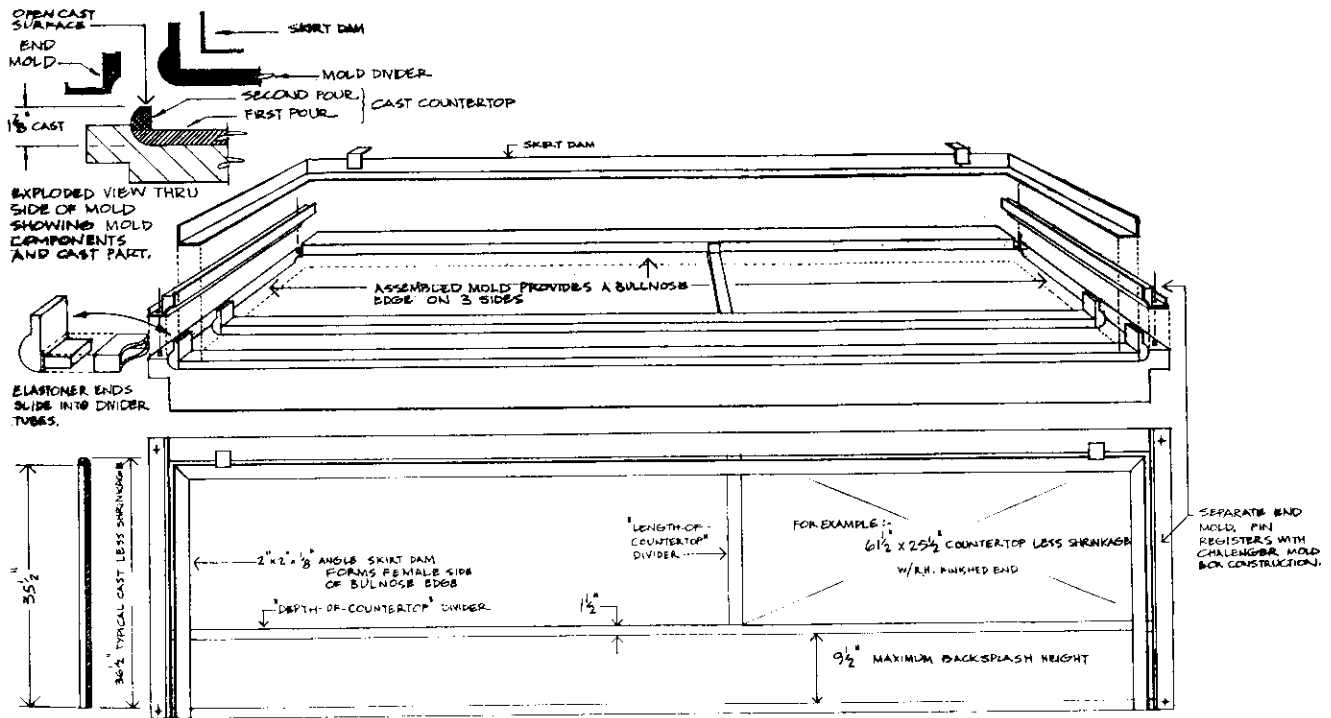

PLAN VIEW OF THE MOLD COMPONENTS SET UP TO PRODUCE A SPECIFIED COUNTERTOP AND BACK SPLASH.

22355D	FF - ALUM DAM (636)	
22355B	YELL/ALUM DAM (636)	
22355R	FF - 636 - RIGHT	
CATALOG No.	DESCRIPTION	LIST PRICE

MALE	22355	636-NB-146" W/2" BLNSE		CAST WEIGHT
FEMALE	22355L	FF - 636 - LEFT		SCALE NO SCALE
INSERT				DATE 5-14-93
NAME	KITCHEN DECK 146" X 36" W/2" BULLNOSE EDGE		©1992	REF. B-PD-1525